

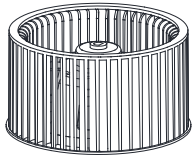

1582761 风轮\*1

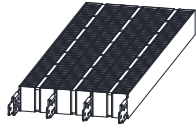

1582756 PTC组件\*1



1582764 电机\*1

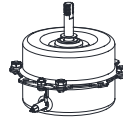

1586409 主控板\*1

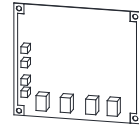

1582760 灯板驱动\*1

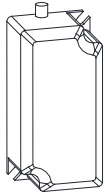

1583248 换气出风口\*1

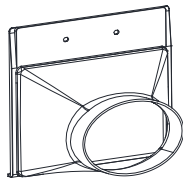

1582769 卡箍\*2

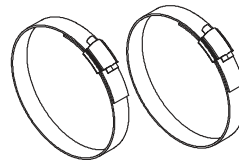

1582770  $\Phi$ 100出风口

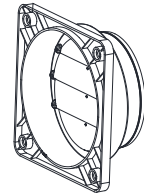

1582768  $\Phi$ 100排风管\*1

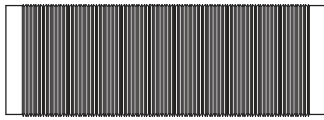

1582771 安装配件包\*1

集成顶用

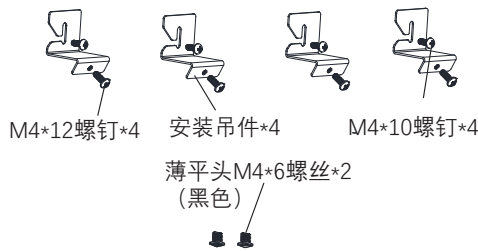

石膏顶用



1586410 墙装遥控器组件\*1

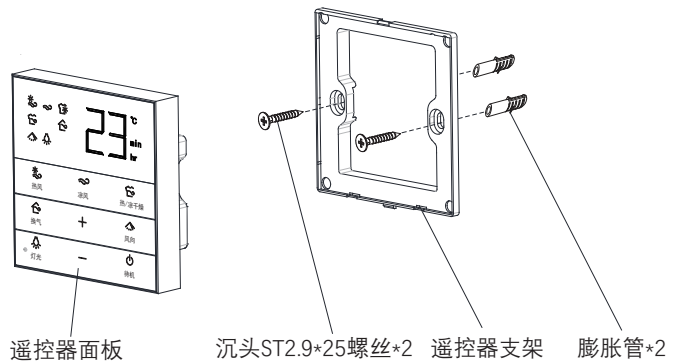
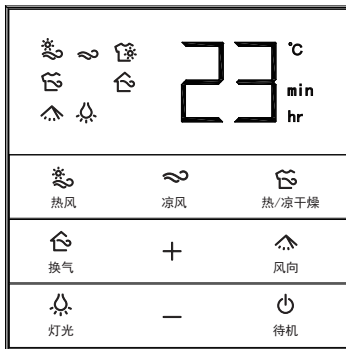

1586411 螺丝包\*1

描述	单位	数量
ST3.5*10自攻螺丝(黑色)	pcs	20
ST3.5*9.5自攻螺丝	pcs	2
M4*6薄平头机丝螺丝(黑色)	pcs	4
M4*10机丝螺丝	pcs	2
ST2.9*6自攻螺丝	pcs	6
ST2.9*16自攻螺丝	pcs	2
M4*16带垫组合机丝螺丝	pcs	4
M4螺母	pcs	6
M8螺母	pcs	1
M4*5螺柱	pcs	2